



成都瑞戈科技有限公司

Chengdu RIG Science & Technology Co.,Ltd.

致力于满足您**一站式**装备解决方案
COMMITTED TO MEETING YOUR ONE-STOP EQUIPMENT SOLUTIONS



成都瑞戈科技有限公司
Chengdu RIG Science & Technology Co.,Ltd.

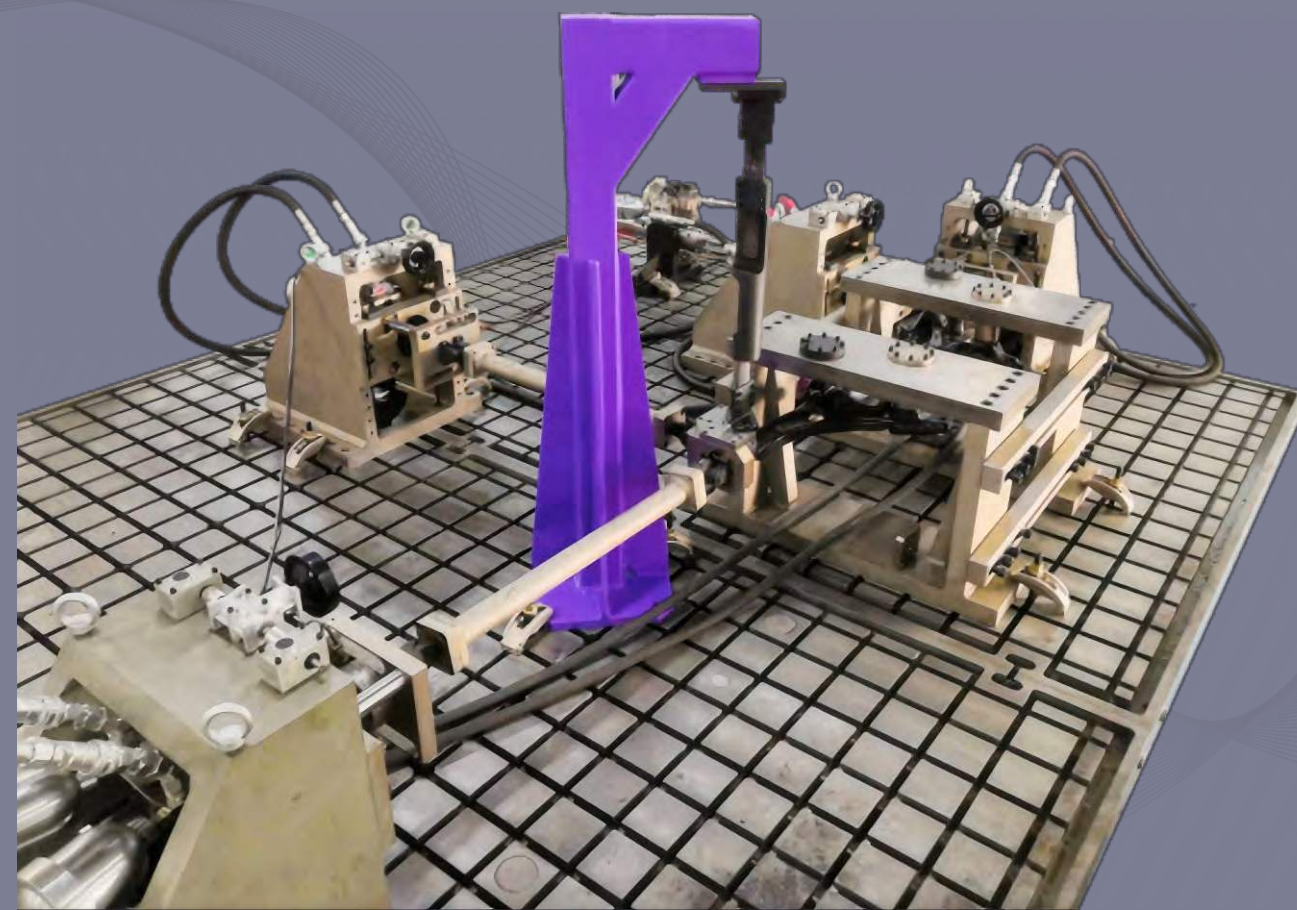

扫一扫 了解更多



中文网站



English Website

地址:成都市大邑县沙渠镇兴城大道16号附1号
Add: No. 16-1, Xingcheng Avenue, Shaqu Town,
Dayi County, Chengdu City, Sichuan, China
Tel: +86-18280086791
Fax: +86-28-85754602
Email: info@rigtesting.com
Website: www.rigtstesting.com
中文网站: www.rigtst.com
中文邮箱: rigtech@rigtesting.com



关于我们...

发展历程 Development History

公司简介 Company Profile

成都瑞戈科技有限公司是一家高品质非标设备服务提供商，从事专用试验设备，自动化生产设备，检测设备的设计，制作，以及工装，夹具，模具，检具等工艺设备的设计及制造，自动化系统集成方案设计咨询服务及人才培养，各类机器人操作、维护人员培训，工厂自动化人才储备培训等，并提供非标设备相关的服务。

公司位于成都市大邑县沙渠工业园区，拥有1500m²的厂房及精良的设备。

我们资深的设计及生产制作团队将为您提供卓越的装备服务。

Researchers, product developers and manufacturers for optimizing the highperformance mechanical test system of components from automobiles, high-railway to aerospace applications.

Chengdu RIG Science & Technology Co., Ltd. rely on the 40 years' experience from the head company as a reputation OEM suspension and steering auto parts manufacturer in China to provide high-end customized equipment solutions, engaged in the designing and manufacturing of durability testing systems, automatic assembly lines and tooling

DEZHOU SANJIA MACHINE

- ▶ **1984** Head Company Chengdu Wangjin Machine Factory Founded
- ▶ **1989** OEM supplier for Chang' an Automotive
- ▶ **1996** OEM for Changan Suzuki Automotive
- ▶ **2001** ISO/9001 Certification
- ▶ **2002** OEM for Cherry Automotive
Global OEM for TRW
- ▶ **2004** Founded sichuan Wangjing Machinery Co., Ltd. ISO/TS16949 certification. Constructed testing laboratory
- ▶ **2007** OEM for Shanghai General Motor
- ▶ **2008** OEM for Geely Automotive
- ▶ **2011** OEM for JTEKT \SMCV\ SHAC
- ▶ **2012** OEM for ZF&SMCV
- ▶ **2014** TRW Global Top Supplier – Steel Award
- ▶ **2015** Chengdu RIG Science & Technology Co., Ltd. founded
- ▶ **2016** Global Supplier for NEXTEER
- ▶ **2019** Subsidiary of Anhui Zhongding Group



合作客户 Cooperated Customers



悬挂和转向部件 耐久性试验设备 SUSPENSION AND STEERING COMPONENTS DURABILITY TEST SYSTEMS

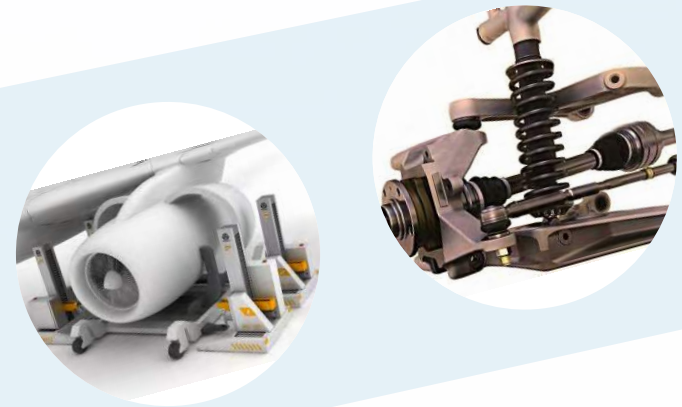
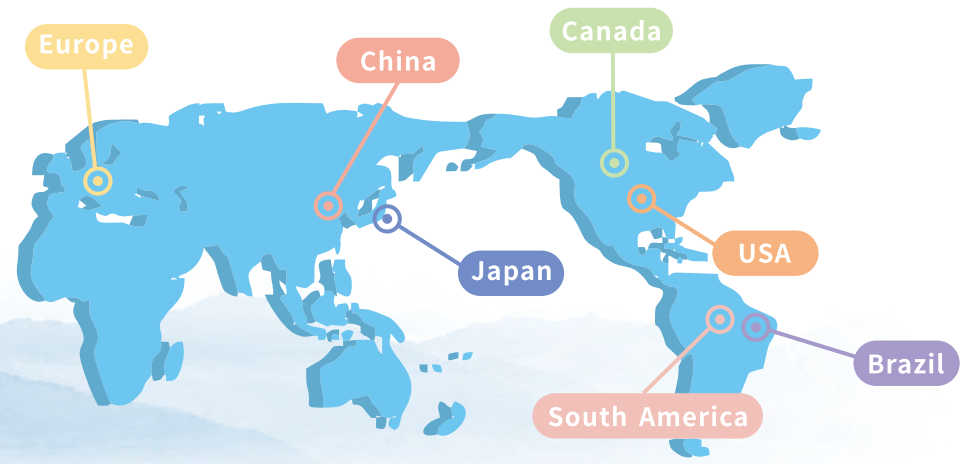

RIG-T040

控制臂耐久试验机

Control Arm Durability Testing Bench



- ◇ 加载 (X.Z) : 0.1~22KN
- ◇ 加载精度: $\pm 5\%$ FS
- ◇ 加载位移 (X.Z) : 0~ ± 25 mm
- ◇ 加载位移精度 (X.Z) : 0.1mm
- ◇ 加载频率 (X.Z) : 0~25Hz
- » Loading : (x.z) : 0.1~22KN
- » Loading Accuracy: $\pm 5\%$ FS
- » Loading Displacement(x.z): 0~ ± 25 mm
- » Loading Displacement Accuracy(x.z):0.1mm
- » Loading Frequency (x.z) : 0~25Hz

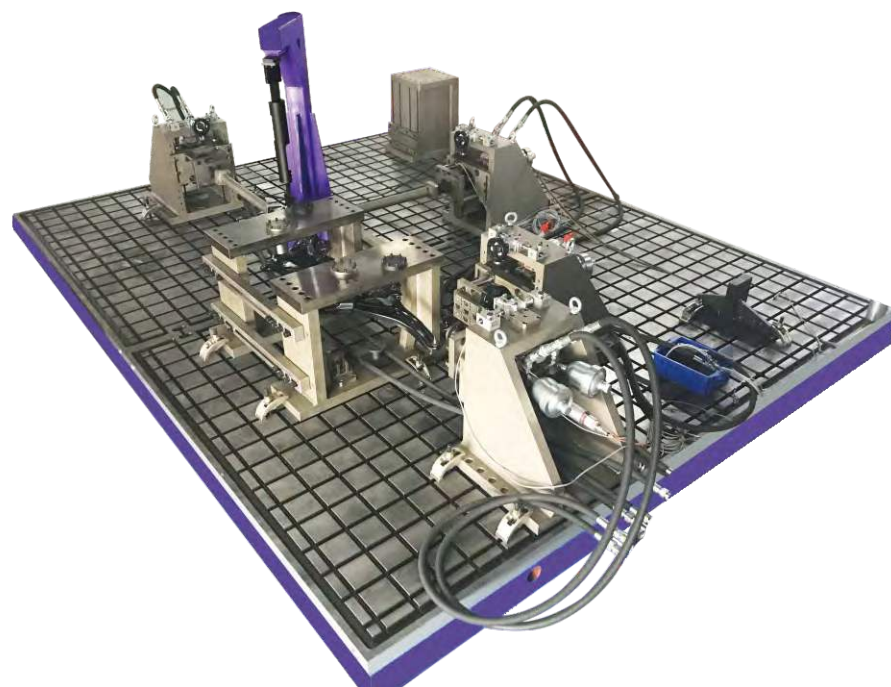

RIG-T086

50KN 四通道三工位球头环境耐久试验机

50KN 4-Axis 3-Station Ball Joint Durability Testing Stand



- ◇ 加载能力
- ◇ 摆动: 0~ ± 90 deg @0~10Hz ± 40 mm
- ◇ 旋转: 0~ ± 90 deg @ 0~2Hz ± 55 mm
- ◇ 径向加载: ± 50 KN 0~20Hz
- ◇ 轴向加载: ± 50 KN 0~20Hz
- ◇ 环境试验箱: -50~120°C
- » Loading Capacity:
- » Max. Oscillation Angle: 0~ ± 90 deg @0~10Hz ± 40 mm
- » Max. Rotating Angle.: 0~ ± 90 deg @ 0~2Hz ± 55 mm
- » Max. Radial Load: ± 50 KN 0~20Hz
- » Max. Axial Load : ± 50 KN 0~20Hz
- » Environment Chamber: -50~120°C

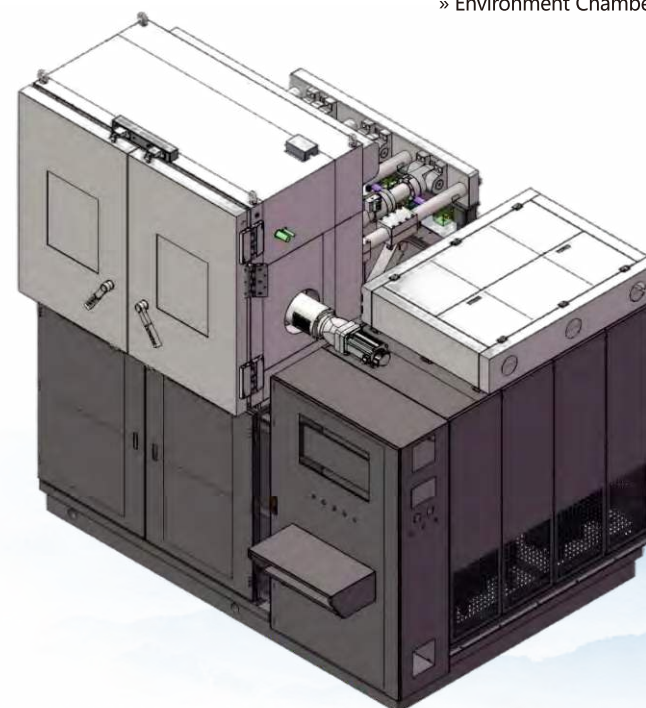

六工位防尘罩密封性试验机 6-Stations Dust Cover Sealing Testing Stand



- ◇ 可同时对6件试样进行密封性能试验
- ◇ 旋转: $0 \sim \pm 45 \text{deg}$ @ $0 \sim 3.3 \text{Hz}$
- ◇ 摆动: $0 \sim \pm 30 \text{deg}$ @ $0 \sim 1 \text{Hz}$
- ◇ 模拟环境温度: $-50 \sim 150^\circ\text{C}$
- ◇ 水、泥水喷淋
- » Max. Rotating Angle: $0 \sim \pm 45 \text{deg}$ @ $0 \sim 3.3 \text{Hz}$
- » Max. Oscillation Angle: $0 \sim \pm 30 \text{deg}$ @ $0 \sim 1 \text{Hz}$
- » Environmental Chamber: $-50 \sim 150^\circ\text{C}$
- » Muddy Water Spray



四通道球头环境耐久试验机 4-Axis Ball Joint Durability Testing Stand

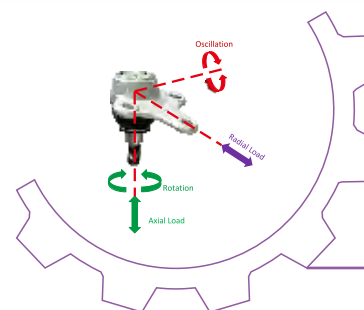

- ◇ 对试样进行摆动、旋转、轴向及径向的伺服加载
- ◇ 加载能力
- ◇ 摆动: $0 \sim \pm 30 \text{deg}$ @ $0 \sim 25 \text{Hz}$
- ◇ 旋转: $0 \sim \pm 45 \text{deg}$ @ $0 \sim 25 \text{Hz}$
- ◇ 径向加载: $\pm 20 \text{KN}$ $0 \sim 20 \text{Hz} \pm 25 \text{mm}$
- ◇ 轴向加载: $\pm 20 \text{KN}$ $0 \sim 20 \text{Hz} \pm 25 \text{mm}$
- ◇ 环境试验箱: $-50 \sim 150^\circ\text{C}$

System Performance

- » Max. Radial Load: $\pm 20 \text{KN}$ $0 \sim 20 \text{Hz} \pm 25 \text{mm}$
- » Max. Axial Load: $\pm 20 \text{KN}$ $0 \sim 20 \text{Hz} \pm 25 \text{mm}$
- » Load Frequency Range: $0 \sim 20 \text{Hz}$
- » Max. Rotating Angle: $0 \sim \pm 45 \text{Deg}$ @ $0 \sim 25 \text{Hz}$
- » Max. Oscillation Angle: $0 \sim \pm 30 \text{Deg}$ @ $0 \sim 25 \text{Hz}$
- » Environmental Chamber: $-50 \sim 150^\circ\text{C}$

System Content

- » 1 Specimen Test Station
- » T-slot Plate With Loading Frames And Fixtures
- » Flextest System Controller And Software
- » Hydraulic Power Supply
- » Rig Installation And Support Services





- ◇ 对试样进行摆动、旋转及径向的伺服加载
- ◇ 加载能力
- ◇ 径向加载：±20KN 0~20Hz ±25mm
- ◇ 加载频率：0~20Hz
- ◇ 摆动：0~±30deg @0~25Hz
- ◇ 旋转：0~±45deg @0~25Hz
- ◇ 环境试验箱：-50~150°C

System Performance

- » Max. Radial Load: ± 20KN 0~20Hz ± 25mm
- » Load Frequency Range: 0-20 Hz
- » Max. Rotating Angle: 0~± 45deg @ 0~25Hz
- » Max. Oscillation Angle: 0~± 30deg @0~25Hz
- » Environmental Chamber:-50~150°C

System Content

- » 3 Specimens Test Stations
- » T-slot Plate With Loading Frames And Fixtures
- » Flextest System Controller And Software
- » Hydraulic Power Supply
- » Rig Installation And Support Services



- ◇ 对产品进行单通道加载的疲劳试验机
- ◇ 加载能力：0~20KN 0~50Hz
- ◇ 工作行程：±30mm
- ◇ 测试速度：0~3m/s

- » Single Channel Load Force For Fatigue Testing
- » Load Capacity:0~20KN 0~50Hz
- » Stroke:±30mm
- » Speed:0~3m/s

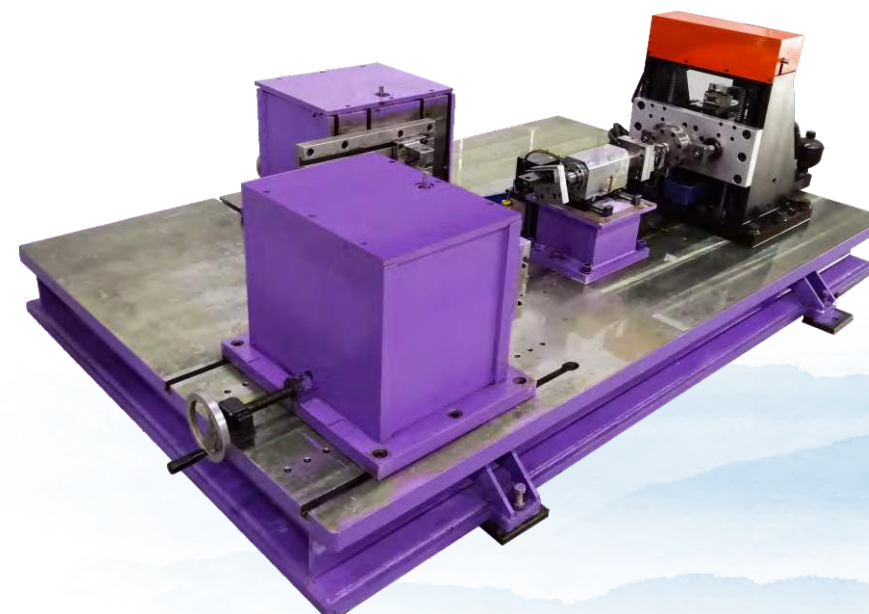

三工位球头疲劳试验机

3-Stations Tie Rod End Fatigue Testing Machine



- ◇ 实现对产品进行单通道加载的疲劳试验机
- ◇ 加载能力: 0~20KN 0~25Hz
- ◇ 工作行程: ±25mm
- ◇ 测试速度: 0~3m/s
- ◇ 可同时对3件试样进行疲劳试验
- ◇ 静压轴承
- » Single Post Load Force For Fatigue Testing
- » Load Capacity:0~20KN 0~25Hz
- » Stroke: ±25mm
- » Speed:0~3m/s
- » 3 Specimens Can Be Tested Simultaneously
- » Hydrostatic Bearing



衬套耐久试验机

Rubber Bushing Durability Testing Machine

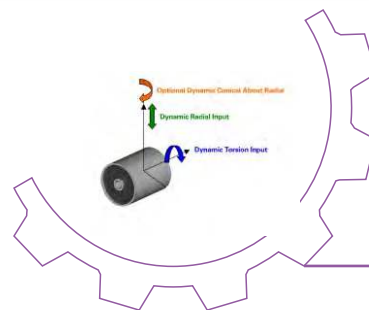

- ◇ 加载力:±50KN
- ◇ 径向行程:±25mm
- ◇ 径向旋转:±22°
- ◇ 轴向旋转:±45°
- ◇ 频率: 100Hz;
- ◇ 径向扭矩:±100Nm
- ◇ 轴向扭矩:±200Nm
- » Force:±50 KN Frequency: 100Hz;
- » Radial Stroke ±25 Mm
- » Radial Torque ±100 Nm
- » Radial Rotation ±22°
- » Axial Torque ±200 Nm
- » Axial Rotation ±45°

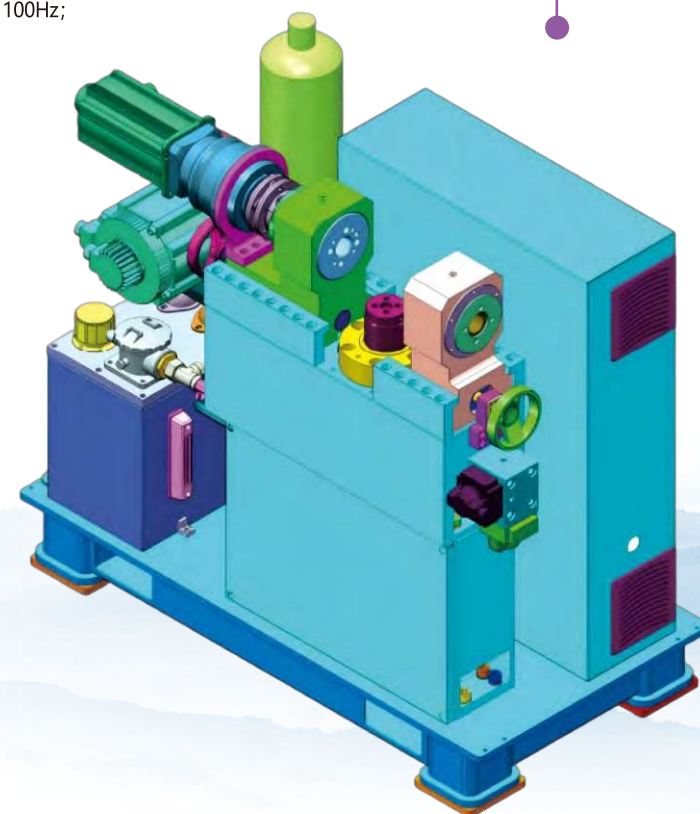



- ◇ 最大加载力: 20KN
- ◇ 作动器行程: $\pm 50\text{mm}$,有效行程: $\pm 40\text{mm}$
- ◇ 最大频率:100Hz,100Hz@ $\pm 0.2\text{mm}$,50Hz@ $\pm 1\text{mm}$,20Hz@ $\pm 3\text{mm}$
- ◇ 最大流量: 40L/min
- ◇ 拉压力传感器量程: 25KN
- ◇ 传感器精度: 0.1%FS
- » Max.Load: 20KN
- » Stroke of Actuator: $\pm 50\text{mm}$,Effective Stroke: $\pm 40\text{mm}$
- » Max.Frequency:100Hz,100Hz@ $\pm 0.2\text{mm}$,50Hz@ $\pm 1\text{mm}$,20Hz@ $\pm 3\text{mm}$
- » Max.Flow: 40L/min
- » Range of Tension Load Cell: 25KN
- » Accuracy of Sensor: 0.1%FS

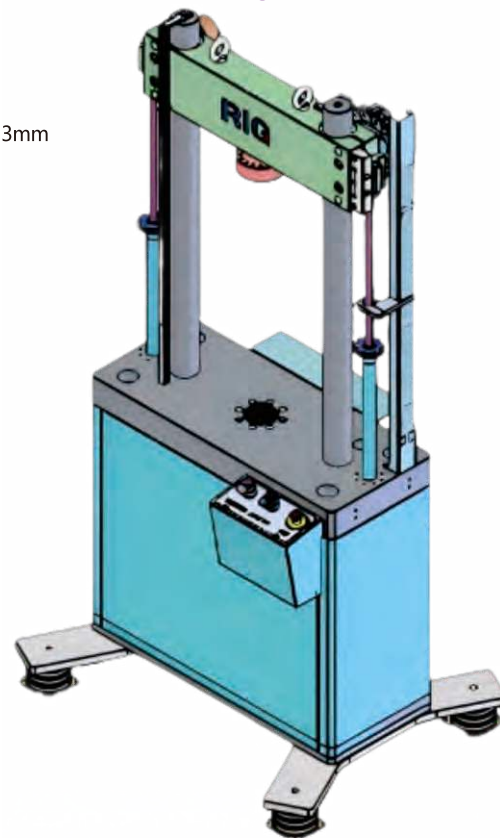

- ◇ 试验摆角: $\pm 20^\circ$
- ◇ 摆动频率: 1-3Hz
- ◇ 试验转角: $\pm 40^\circ$
- ◇ 转动频率: 0.3-1Hz
- ◇ 单件泥水喷射流量: 0.5L/min ~ 3L/min
- » Test Oscillation Angle: $\pm 20^\circ$
- » Oscillation Frequency: 1-3 Hz
- » Test Rotation Angle: $\pm 40^\circ$
- » Rotation Frequency: 0.3-1 Hz
- » Single Nozzle Water Jet Flow Rate: 0.5 L/min To 3 L/min

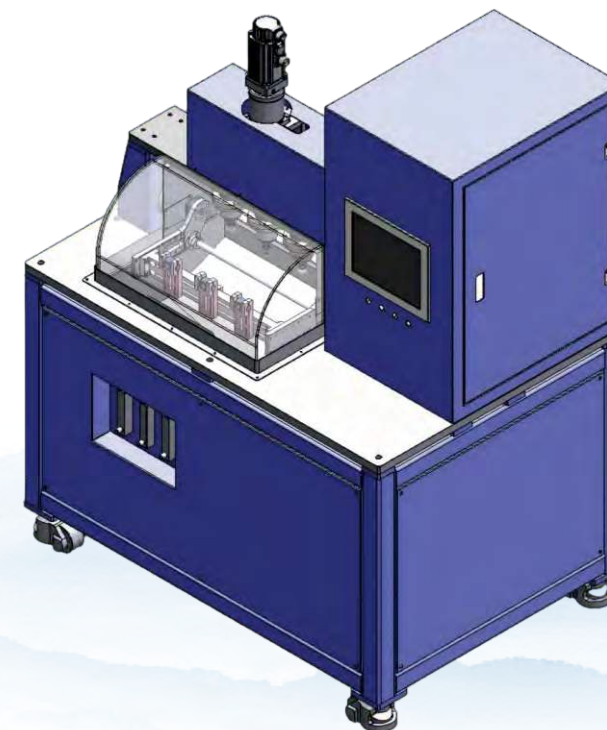

RIG-T153

空压机高温高湿度耐久试验机

Air Compressor High-Temperature Durability Testing



- ◇ 供电电压: 0~60V
 - ◇ 供电电流: 0~120A
 - ◇ 充气压力: 120bar
 - ◇ 产品温度: RT~130°C
 - ◇ 采样频率: 0~10KHz
 - ◇ PWM频率: 300~30KHz
- » Voltage Supply: 0~60V
» Electric Current Supply: 0~120A
» Pressure of Gas-filled: 120bar
» Temperature of Product: RT~130°C
» Sampling Frequency: 0~10KHz
» PWM Frequency: 300~30KHz



RIG-T057

减震器阻尼力耐久试验机

Shock Absorber Durability Testing Machine



- ◇ 加载力: ~15KN
- ◇ 行程: ~±150mm
- ◇ 加载速度: ~1m/s

System Performance

- » Max.load:~15KN
- » Max.Speed:~1m/s
- » Stroke:~150mm

System Content

- » Single-station,multi-station,With Chamber, Side-load As Options
- » Vertical-horizontal Tilting Assembly
- » High-low Temperature Chamber
- » Road Slurry Chamber
- » Rig Installation And Support Services



- ◇ 加载力: 0.1 ~ ±12.5KN
- ◇ 行程: 0 ~ ±90mm
- ◇ 加载速度: 0 ~ 2m/s

- » Loading Force: 0.1 ~ ±12.5KN
- » Stroke : 0 ~ ±90mm
- » Loading Velocity: 0 ~ 2m/s

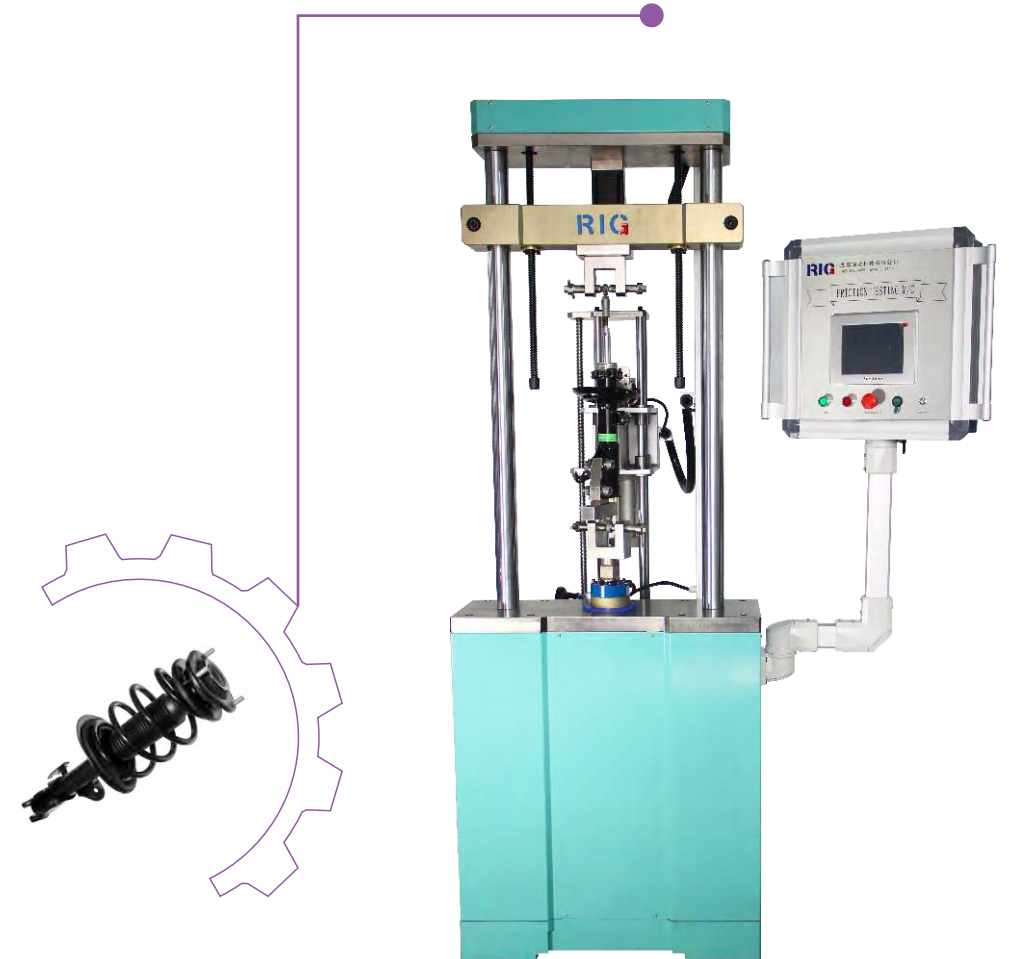

- ◇ 加载力: 0.1 ~ ± 1KN
- ◇ 行程: 0 ~ ± 50mm 精度: 0.001mm
- ◇ 加载速度: 0 ~ 10mm/s
- ◇ 侧向力: ~ ± 1KN

- » Loading Force: 0.1 ~ ±1KN
- » Stroke : 0 ~ ± 50mm, Accuracy: 0.001mm
- » Loading Velocity: 0 ~ 10mm/s
- » Lateral Force: ~ ±1KN



- ◇ 范围: 20Nm
- ◇ 精度: $\pm 0.05\text{Nm}$
- ◇ 加载范围: 0~20KN

- » Test The Oscillation And Rotation Torque Under The Loading
- » Range: 20nm Accuracy: $\pm 0.05\text{nm}$
- » Load Range:0~20KN

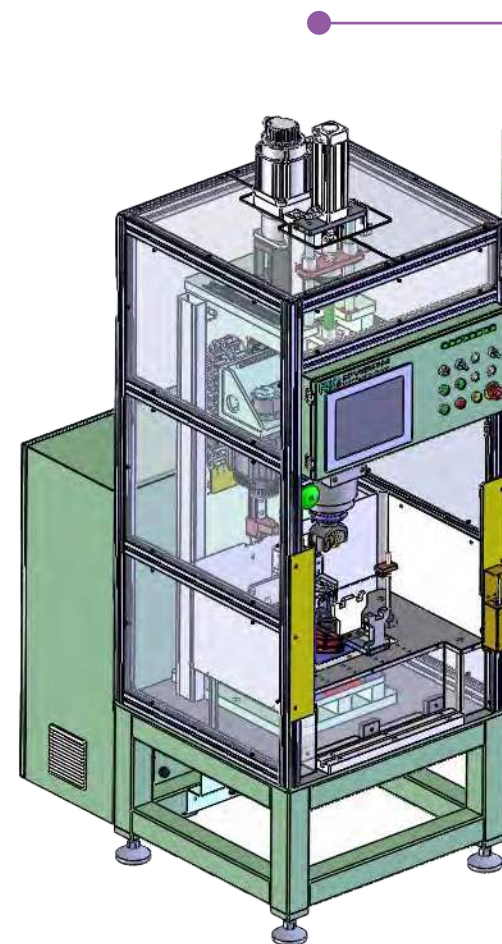
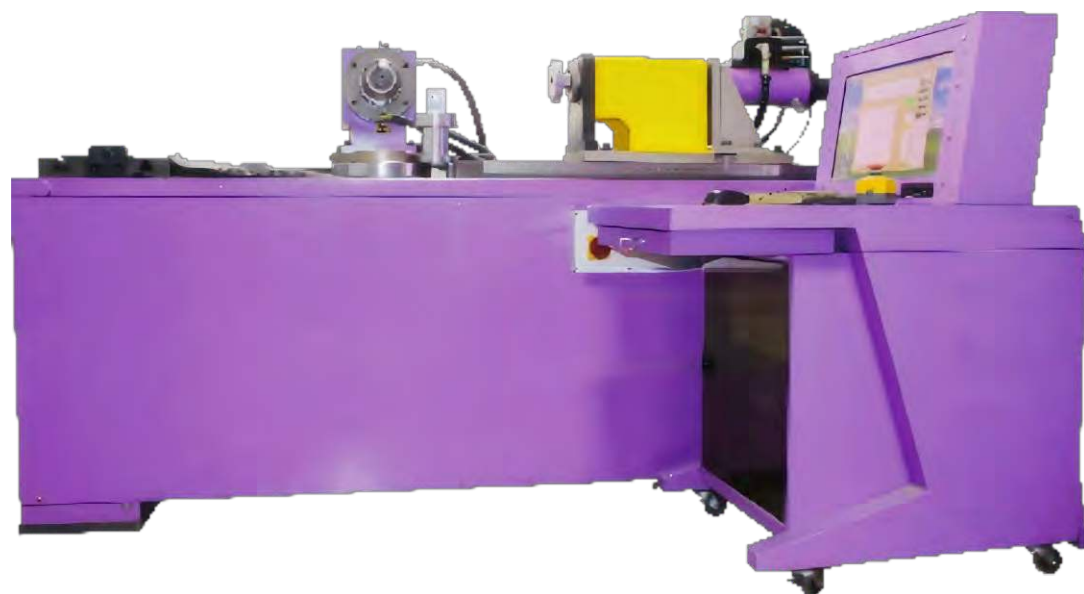

- ◇ 设备节拍: 10s
- ◇ 最大旋铆力: 50KN
- ◇ 最大预压力: 3KN
- ◇ 最大转速: 120RPM
- ◇ 行程: 100mm
- ◇ 设备尺寸: 800X1400X2300
- ◇ 气压: 0.5MPa (min)

- » Machine Time :10s
- » Max Rolling Force :50KN
- » Max Pre-pressing :3KN
- » Max Rotation Speed :120RPM
- » Stroke :100mm
- » Machine Size : 800x1400x2300
- » Air Pressure : 0.5mpa (min)

防尘罩装配机
Dustcover Assembly Machine

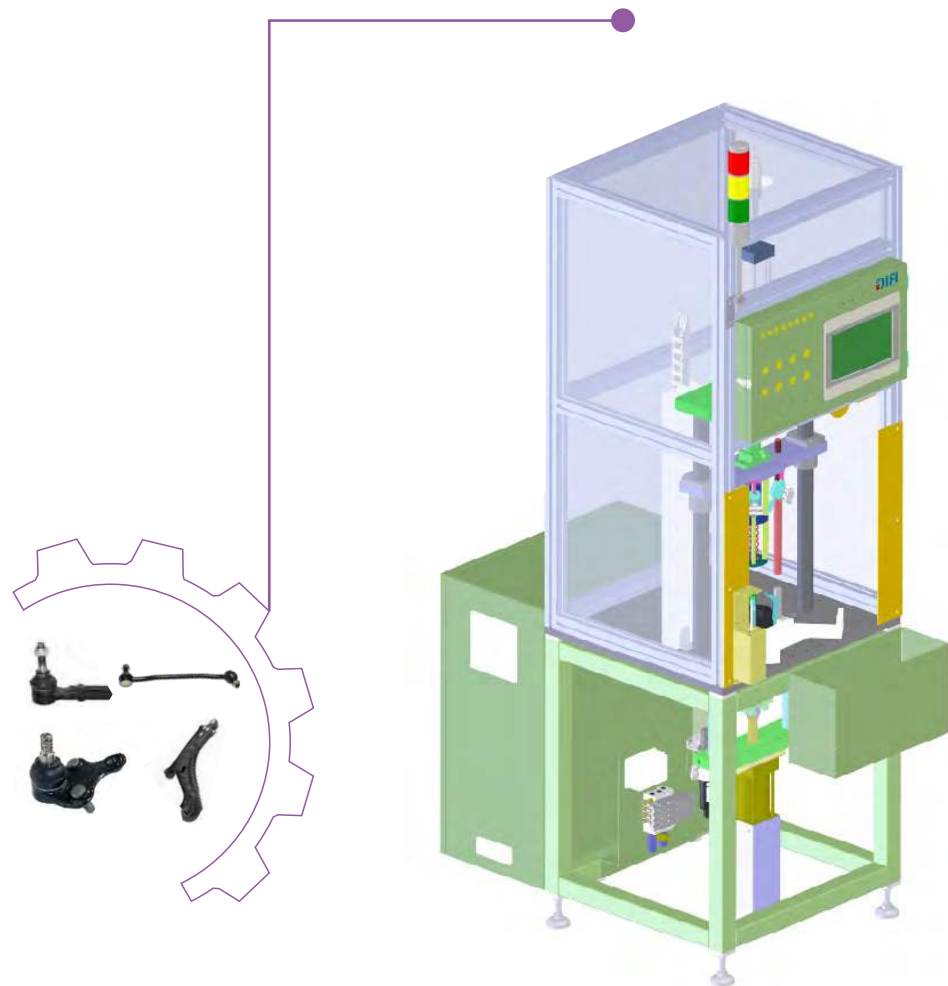

- ◇ 设备节拍: 10s
- ◇ 设备尺寸: 600*700*2000
- ◇ 气压: 0.5MPa (min)

- » Machine Time : 10s
- » Machine Size : 600*700*2000
- » Air Pressure : 0.5mpa (min)

100T三点压铆机
Three-points Riveting Press Machine



Three-Point Riveting
simultaneously

- ◇ 设备节拍: 10-12s
- ◇ 最大压装力: ≤100T
- ◇ 行程: 200mm(含增压行程15mm)
- ◇ 三点独立压装和独立压装力检测

- » Machine Time: 10~12s
- » Max. pressing Force: 100t
- » Stroke: 200mm(including Boost Stroke)
- » Three-point Independent Pressing And
» Compression Force Detection

RIG-A054

连接杆力矩检测机

Stabilizer Link Torque Measuring Machine

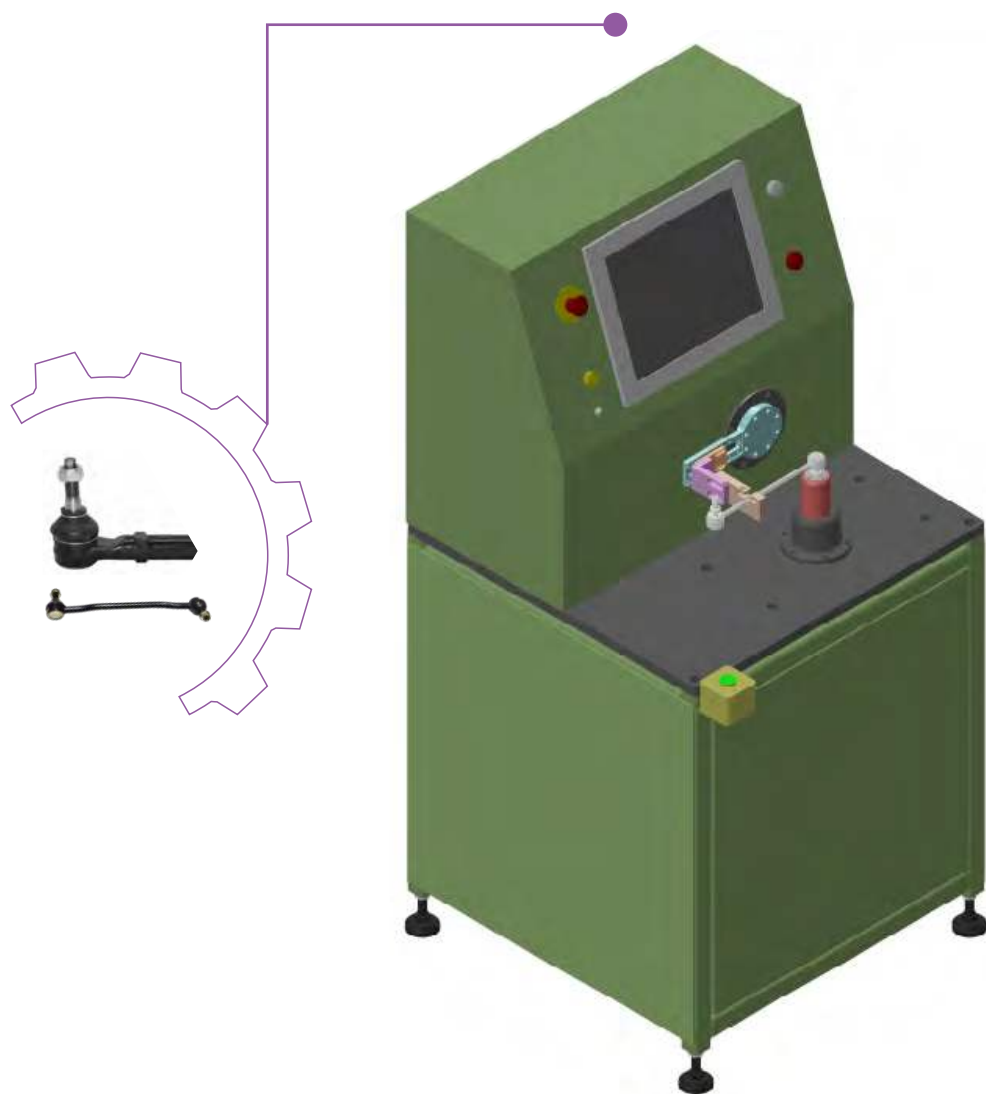

- ◇ 设备节拍: 10-15s
- ◇ 设备尺寸: 700*700*1500
- ◇ 气压: 0.5MPa (min)

- » Machine Time : 10-15s
- » Machine Size :700*700*1500
- » Air Pressure : 0.5mpa (min)

RIG-A056

100KN压力机

100KN Pressing Machine

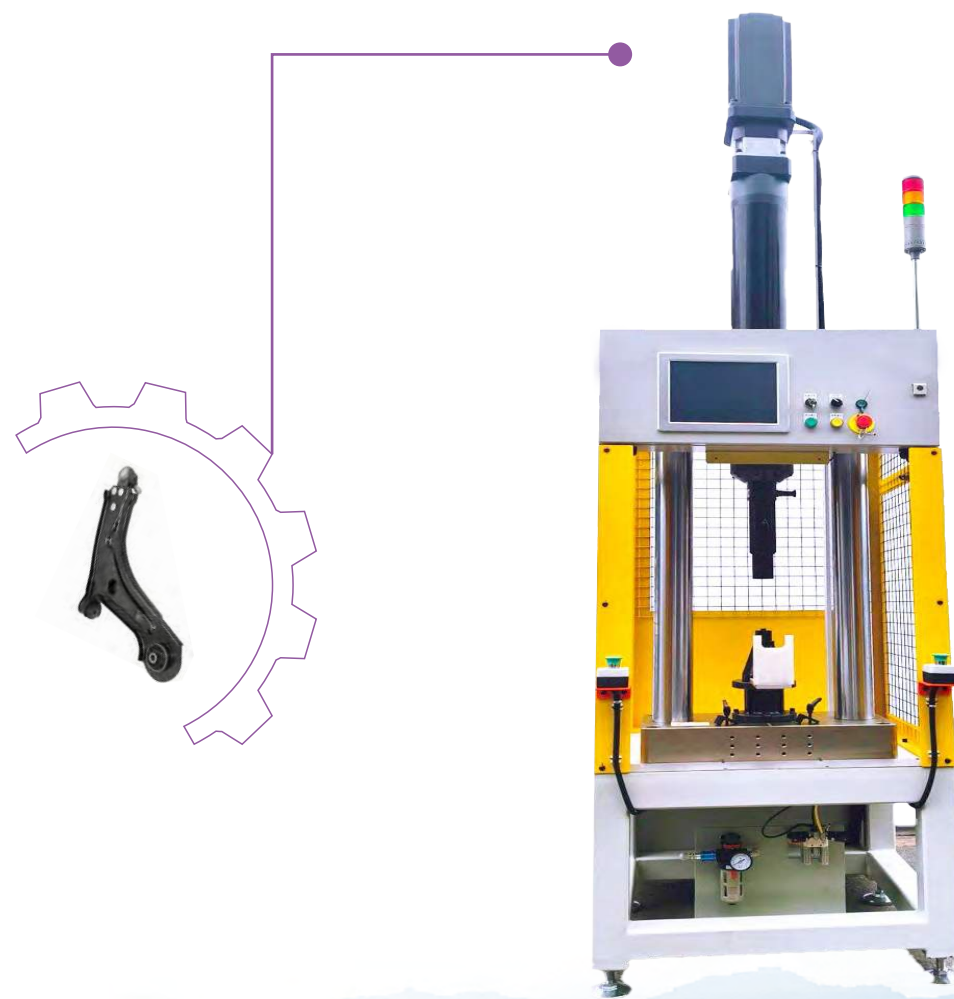

- ◇ 压入力: 0~100KN
- ◇ 空载最大速度: 60mm/s
- ◇ 有效行程: 300mm
- ◇ 力-位移数据采集及显示、合格判定

- » Pressing Force: ~ 100KN
- » Max.unloading Speed:60mm/s
- » Valid Stroke:300mm
- » Force And Displacement Data Acquisition AndDisplay, Qualification Judgment

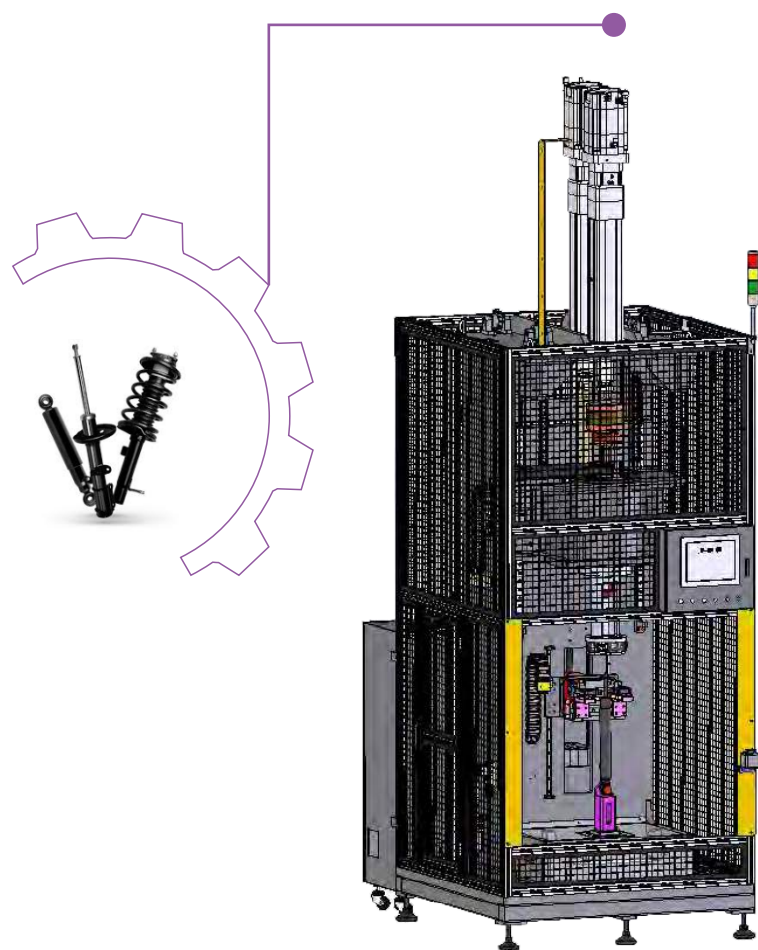

- ◇ 节拍: 15s
- ◇ 旋铆力: 50KN
- ◇ 预压力: 50KN
- ◇ 最大转速: 1000RPM
- ◇ 行程: 400MM

- » Machine Time:15s
- » Rolling Force:50KN
- » Max.pre-pressing:50KN
- » Max.rotation Speed:1000RPM
- » Stroke:400mm

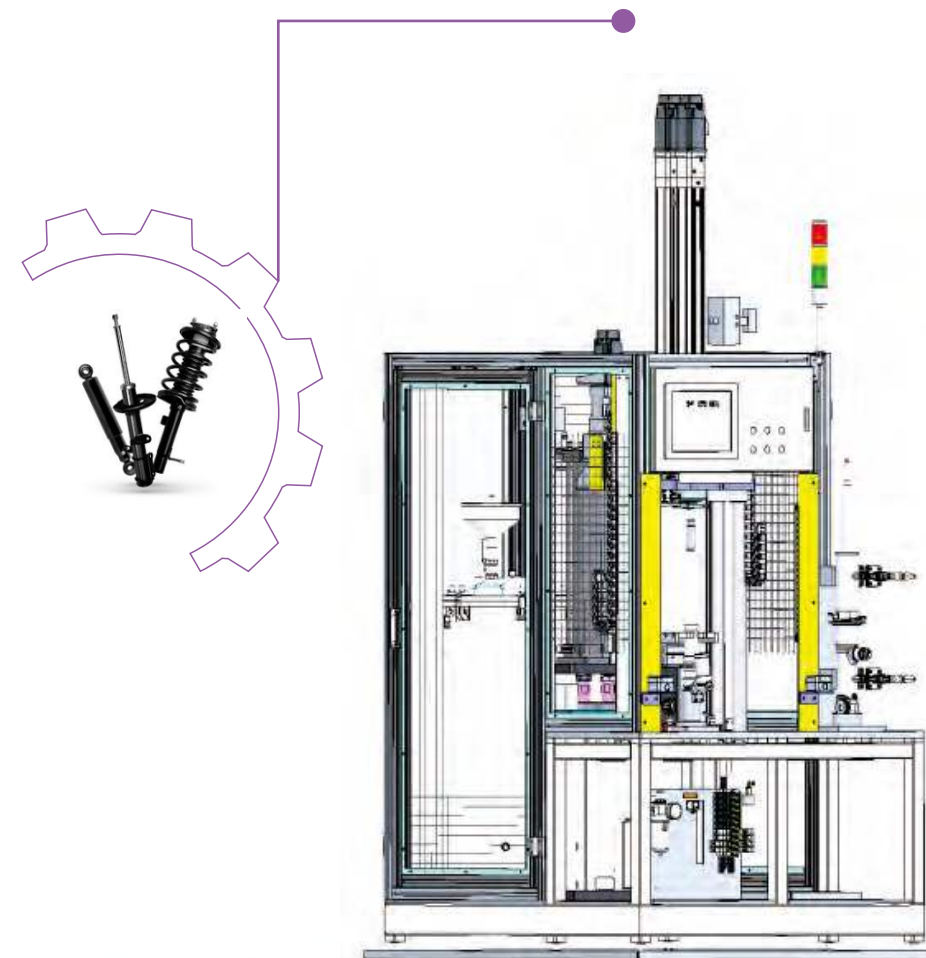

- ◇ 单次注油量: 50-300ml
- ◇ 注油精度: ±5ml
- ◇ 最大真空度: 30pa
- ◇ 显示屏显示封口过程参数, 带密码管控
- ◇ 节拍: 60秒

- » Single Oil Filling Volume: 50-300ml
- » Oil Filling Accuracy: ±5ml
- » Maximum Vacuum Degree: 30pa
- » The Display Screen Shows The Sealing Process Parameters, With Password Control
- » Machine Time:60s

内拉杆自动组装生产线 Inner Ball Joint (IBJ) Assembly Line

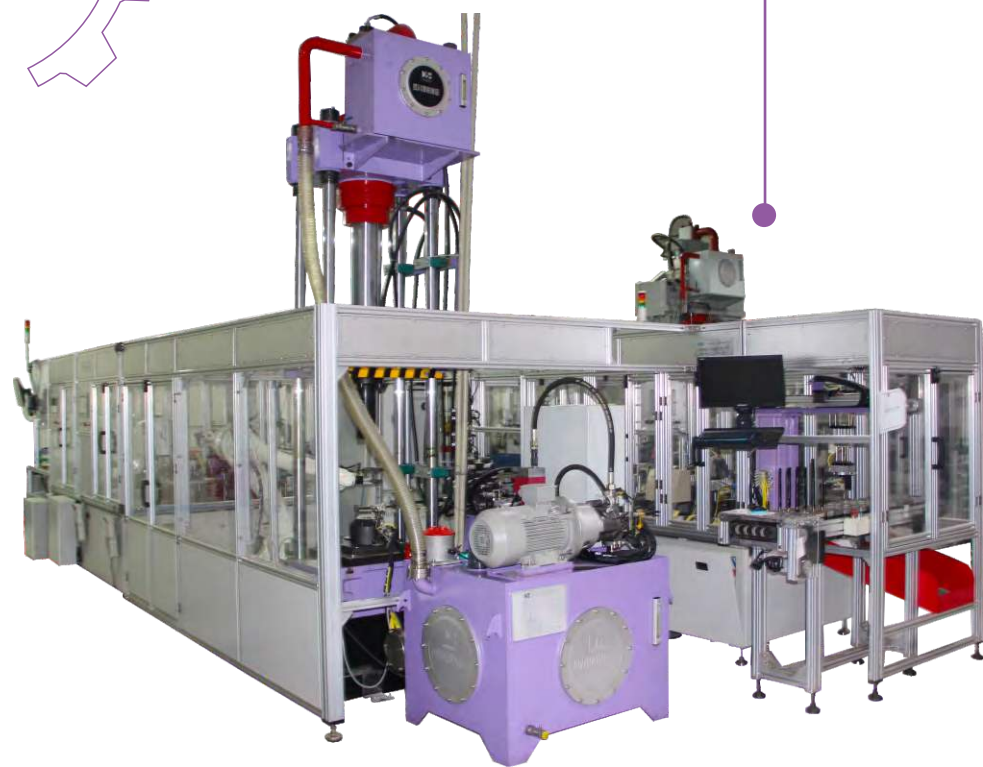

- ◇ 节拍: 12秒/件
- ◇ 组件自动上料
- ◇ 液压伺服压装
- ◇ 力矩检测
- ◇ 全程可追溯
- ◇ 具有多项在线检测及防错功能

- » Tact/cycle Time:12s/pcs
- » High Speed Transferring System
- » Automatic Feeding Of Components
- » Servohydraulic Press
- » Torque Control
- » Robotized Palletizing System
- » Fully Traceability

OBJ外拉杆自动组装生产线 Outer Ball Joint(OBJ) Assembly Line



- ◇ 组件自动上料
- ◇ 力矩检测
- ◇ 全程可追溯
- ◇ 具有多项在线检测及防错功能

- » High Speed Transferring System
- » Automatic Feeding Of Components
- » Oscillation Torque Control
- » Rotation Torque Control
- » Robotized Palletizing System
- » Fully Trazability

RIG-A230

连接杆自动组装生产线

Automatic Stabilizer Link Assembly Line

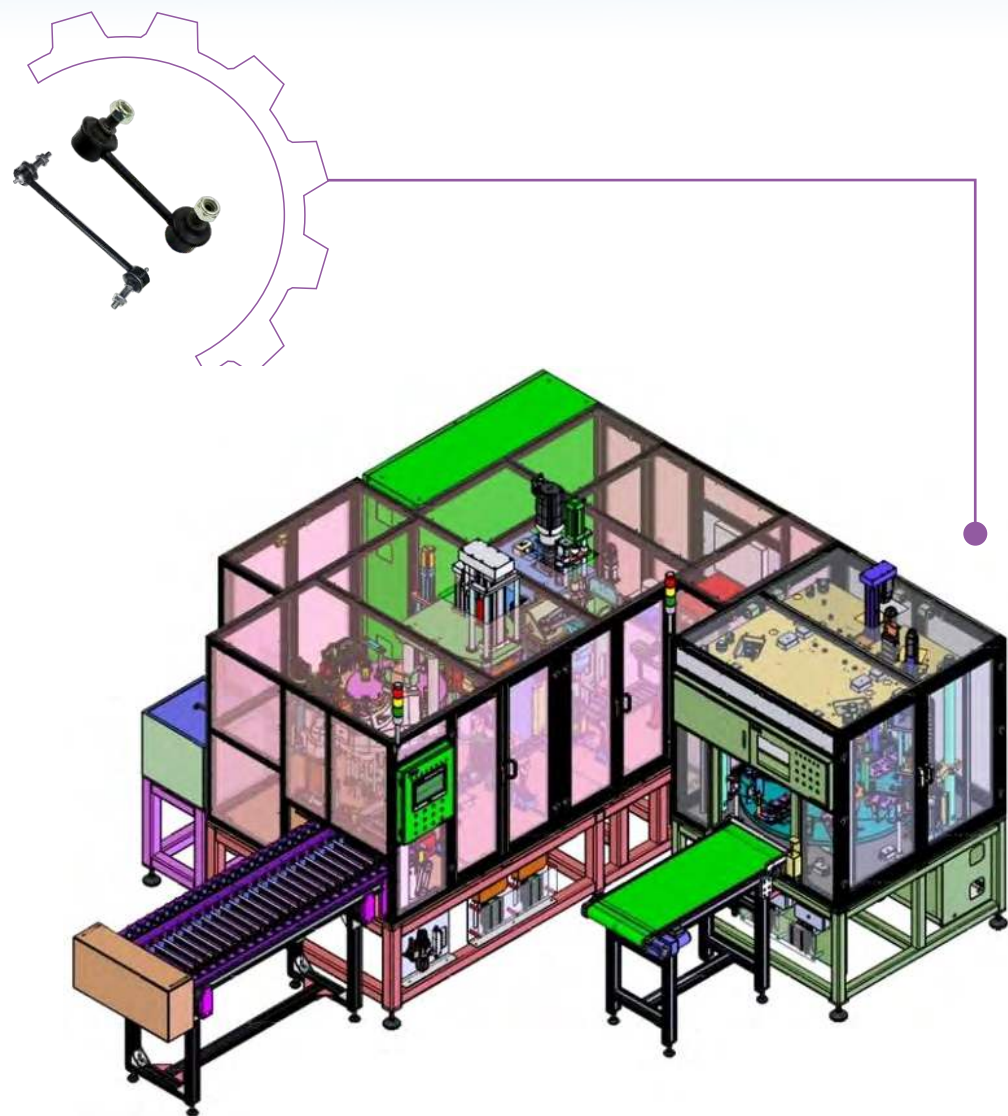

- ◇ 节拍: 12秒/头
- ◇ 组件自动上料
- ◇ 力矩检测
- ◇ 全程可追溯
- ◇ 具有多项在线检测及防错功能

- » Cycle Time:12s/per Side
- » With Multi On-line Function Detection And Error Proof

RIG-A257

球头自动滚光滚丝机

Automatic Ball Pin Thread Rolling Machine

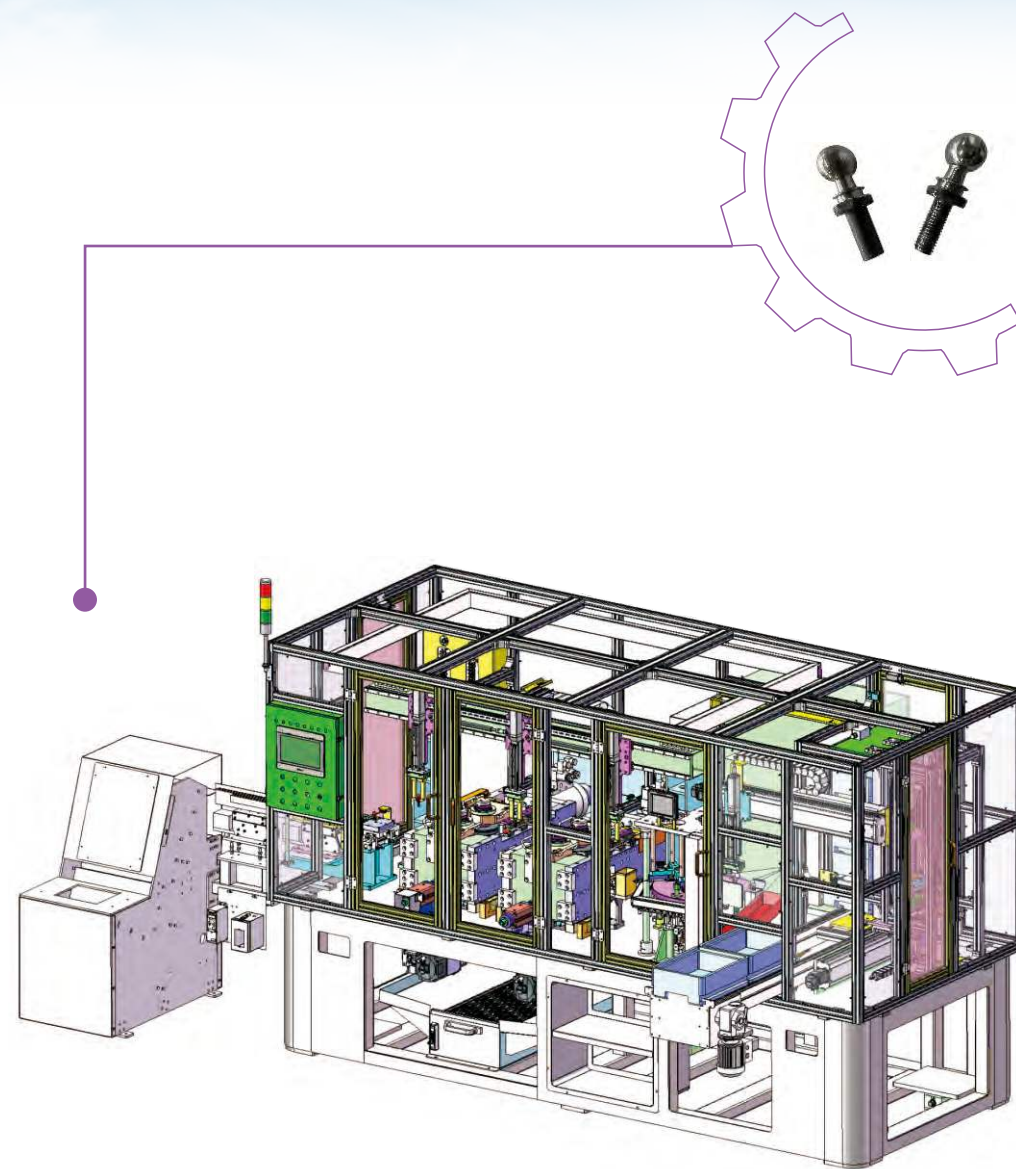

- ◇ 节拍: ≤8秒;
- ◇ 最大闭合压力: 150KN;
- ◇ 加工工位: 2个;
- ◇ 机器尺寸: 4800*2800*2320;
- ◇ 电源: 30KW AC380V 3PH+N 50/60Hz

- » Cycle Time:≤8s
- » Hydraulic Closing Force: 150KN
- » Rolling Axis: 2 Stations
- » Machine Size: 4800*2800*2320
- » Power Supply:30KW AC380V 3PH+N 50/60Hz

RIG-A113

自动焊机 Automatic Welding Machine

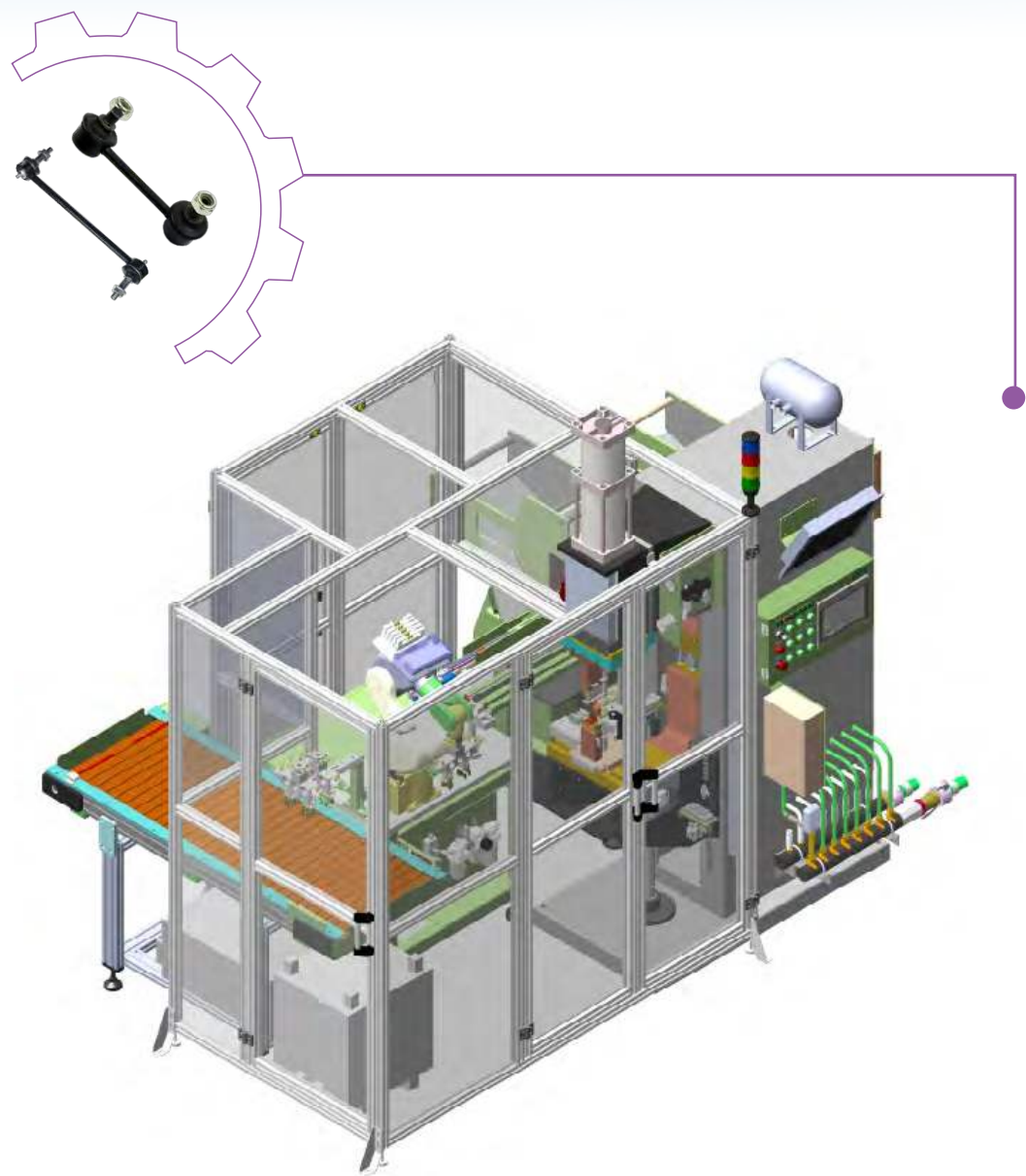

- ◇ 设备节拍: 12s
- ◇ 设备尺寸: 3300*2050*2450(W*L*H)
- ◇ 气压: 0.5MPa (min)

- » Machine Time : 12s
- » Machine Size : 3300*2050*2450(w*l*h)
- » Air Pressure : 0.5mpa (min)

RIG-A162

数控高压清洗机 CNC High-Pressure Water Spray Machine

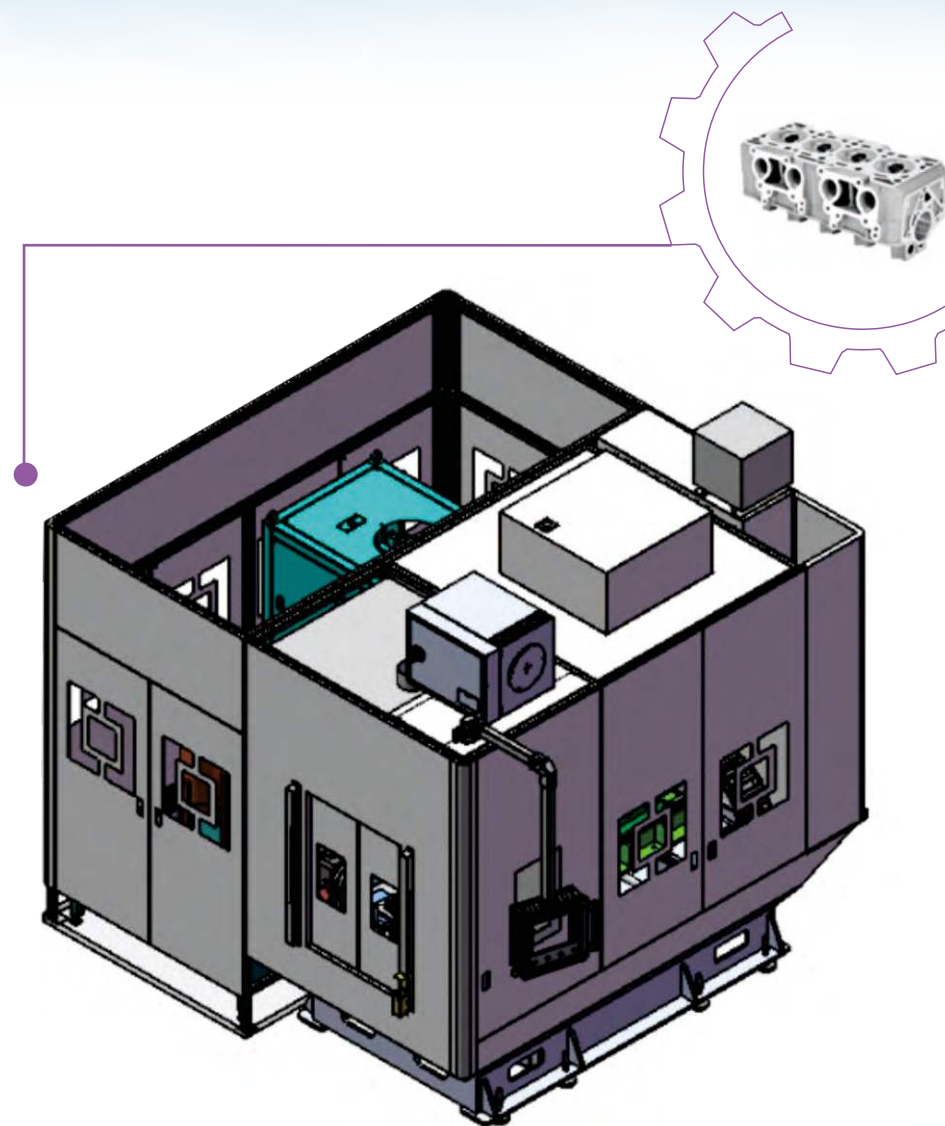

- ◇ XYZ行程: 600*600*600
- ◇ XYZ移动速度: 45m/min
- ◇ 主轴间距: 250mm
- ◇ 高压泵压力: 最大50Mpa
- ◇ 高压泵流量: 20L/min
- ◇ 工作噪音: < 80分贝
- ◇ 电源: 三项AC380V±10%, 50Hz
- ◇ 整机功率: 39Kw
- ◇ 整机重量: 6.5T

- » Xyz Travel: 600*600*600
- » Xyz Moving Speed: 45 M/min
- » Spindle Spacing: 250 Mm
- » High-pressure Pump Pressure: Maximum 50 Mpa
- » High-pressure Pump Flow Rate: 20 L/min
- » Operating Noise: <80 Db
- » Power Supply: 3-phase Ac380v±10%, 50Hz
- » Total Power: 39 Kw
- » Machine Weight: 6.5 T

RIG-A253

主销/控制臂生产线

Ball Joint/ Control Arm Assembly Line

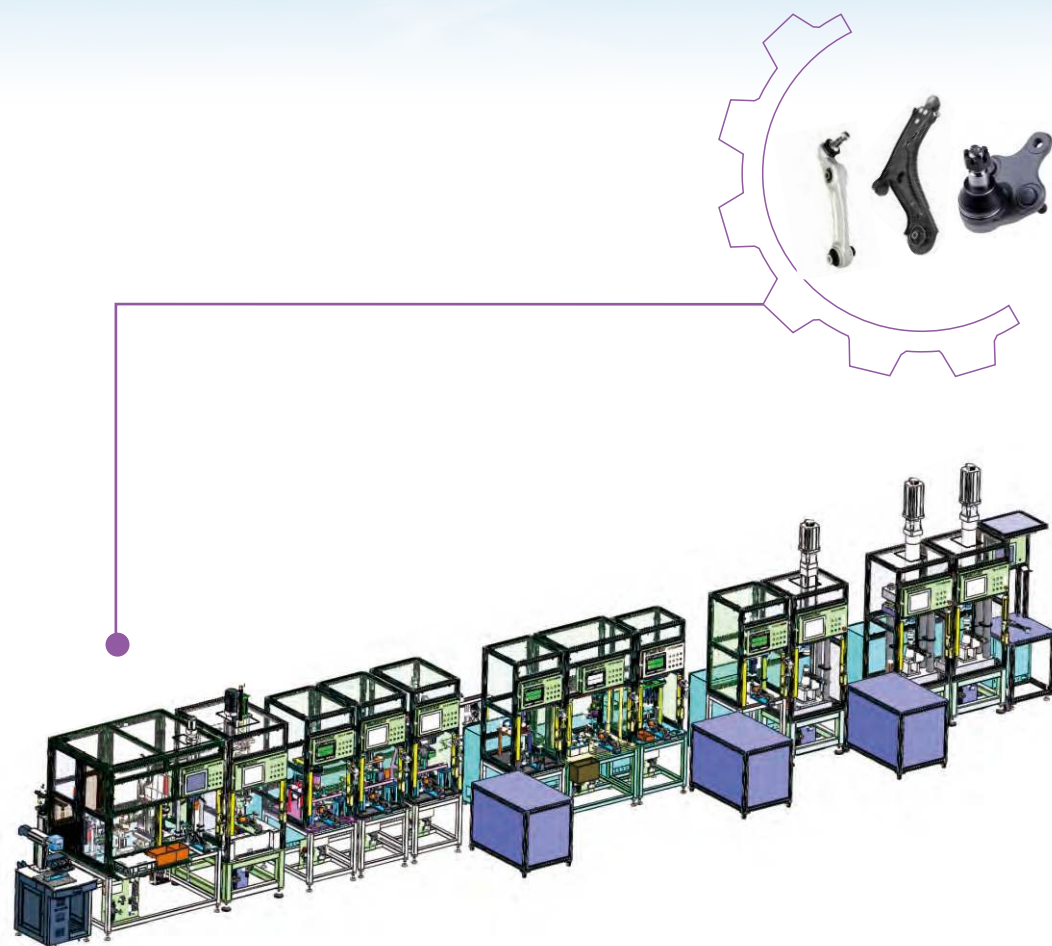

定量注脂→组件压装→旋铆→预摇摆→摆动力矩检测→旋转力矩检测

Quantitative greasing→component press-fitting→rolling, pre-swing→swing torque test→rotation torque test

口部注脂→防尘罩装配→簧圈装配→防尘罩气密性检测→衬套压装

Mouth greasing→dust cover assembly→ring assembly→dust cover sealing test→bushing press fitting

RIG-A109

冲床三次元自动化连线

Punch Three-dimensional Automation Production Line

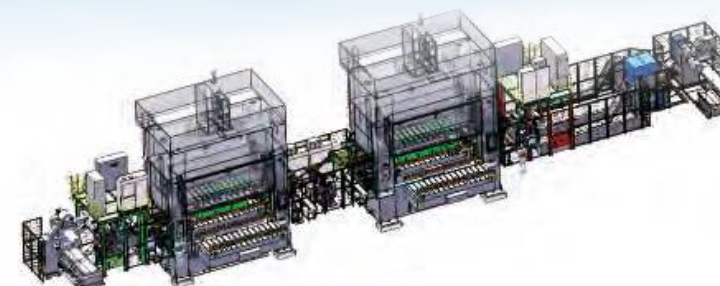

1000吨与800吨冲床自动化联机及三次元机械手

1000-ton and 800-ton punch press automatic connection and three-dimensional manipulator

RIG-A169

铝合金储气罐焊接自动装配线

Aluminum Alloy Gas Storage Tank Auto Welding Production Line

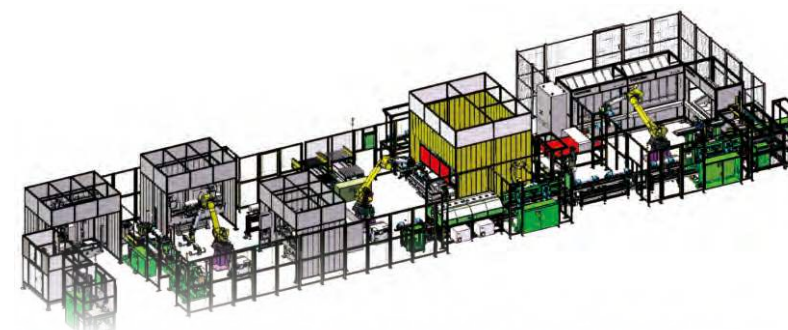

乘用车空气悬挂系统铝合金储气罐自动焊接生产线

Passenger car air suspension system aluminum alloy gas storage tank auto welding production line

清洗→组对→端盖环缝焊接→接头焊接→支架焊接→氦检→尺寸检测→贴标

Cleaning→teaming→end cap ring seam welding→joint welding→bracket welding→helium inspection→dimension inspection→labeling